

# *EZWall-Pro*

## *User Manual*

### *Multi-Format Video Wall Processor*



**4x4 HD Video Wall Controller**  
**HDMI, VGA, Composite and Y/Pb/Pr Inputs**  
**Integrated USB Media Player**

**Smart-AM**  
SMART AUDIO VIDEO INNOVATION

TABLE OF CONTENTS	
WHAT'S IN THE BOX?	2
INTRODUCTION	3
FEATURES	3
APPLICATIONS	3
TECHNICAL SPECIFICATIONS	4
HARDWARE INSTALLATION	5
FRONT PANEL CONTROL	6
RS-232 COMMANDS	7
IR REMOTE CONTROL	8
CONTROL VIA ETHERNET	9-11
FIRMWARE UPDATE	12-13
LIMITED WARRANTY STATEMENT	14

WHAT'S IN THE BOX?		
PART NO.	QTY	DESCRIPTION
EZW4x4-S	1	EZWall-Pro: 4x4 Video Wall Controller
CCPWR06	1	Power supply cord
EZ-RMT (NEC 38 KHz)	1	IR Remote Control
SM-EYE	1	IR Receiver
	1	Quick Start Guide



Figure 2-1



Figure 2-2

## INTRODUCTION

Thank you for choosing Smart-AVI EZWall-Pro for your video wall solution. The EZWall-Pro offers top-notch HD DVI output for five different type of signal inputs. Create striking 4x4 wall displays easily with simple signal-switching and flexible connectivity. The EZWall-Pro even features a fully-integrated USB media player, perfect for populating your displays with enticing digital content.

Capable of expanding any supported video input to twelve large-scale screens at 1080p, the EZWall-Pro showcases stunning picture quality and SmartAVI products' signature ease of use. In this guide, you will learn how to install and optimize your experience with the EZWall-Pro using basic steps. We will cover setting the hardware up, activating and connecting your systems, and offer helpful tips on how to best use EZWall-Pro's excellent selection of picture modes to enhance your video wall. Congratulations again on choosing EZWall-Pro and SmartAVI as your go-to video wall solution!

## FEATURES

- 16 screen (4x4) multi-Layout, multi-format video wall controller
- Outputs: (16) DVI single-link
- Inputs: (2) HDMI, (1) VGA, (2) Composite AV, (1) Y/Pb/Pr
- Integrated USB Media Player for digital video, imagery and audio
- Internal EDID learning
- 1080p (1920x1080 @ 60Hz) Full HD resolution output
- No additional hardware or software required
- Supports control via Front Panel Buttons
- Supports control via IR Remote control
- Supports control via RS-232
- Supports control via TCP/IP
- HDCP and HDMI 1.4 compliant

## APPLICATIONS

- Corporate or Educational Presentations
- Airport Installations
- Wall Displays
- Digital Signage
- Dealer Rooms
- Control Rooms
- Shopping Centers
- Security
- Point-of-Sale
- Entertainment Venues
- Corporate Lobbies
- Restaurants

## TECHNICAL SPECIFICATIONS

VIDEO	
Output Resolutions	Up to 1080P (1920x1080@60Hz)
Input Resolutions	Up to 1080P (1920x1080)
Input Video Signal	1.2 volts
Input DDC Signal	5 volts
Outputs	(16) DVI-D
DVI Format	Single-link
Inputs	(2) HDMI, (1) VGA, (2) AV Composite, (1) Y/Pb/Pr, (1) USB 2.0 Type A
HDCP Compliance	1.0/2.0
Audio	(1) 3.5 mm input, (1) 3.5 mm output
CONTROL	
Front Panel	Tactile Switches
RS-232	DB9 Female, 9600, N, 8, 1, no flow control
IR Remote Control	EZ-RMT (NEC 38 KHz)
Ethernet (TCP/IP)	RJ-45
OTHER	
Power	100-240 VAC
Dimensions	17.125" W x 3.625" H x 7.5" D
Weight	8.3 lbs.
<b>USB MEDIA PLAYER</b>	<b>USB player requires the IR Remote Control for navigation and media selection.</b>
Signal Type	USB 2.0, 1.1, and 1.0 (Type A)
Video Formats *	MJPEG, MPEG-1, MPEG-2, MPEG-4, Vvid, DivX H.264
Max Resolution	1920x1080 @30fps
Max Data Rate	20 Mbps
Audio Formats *	MP3, WMA, AAC, MP2, PCM, AC3
Photos Max Resolutions *	JPEG - 15360x8640, BMP - 9600x6400, PNG - 9600x6400
Other	Max TXT resolution: 1200x800 Max ANSI/UNICODE GB/UTF8 file size: 1MB

\*PLEASE NOTE: EZWall-Pro only supports the primary formats listed above. Any unlisted formats are not compatible with EZWall-Pro.

## HARDWARE INSTALLATION

1. Position EZWall-Pro conveniently and keep it unplugged.
2. Connect DVI output cables between the EZWall-Pro and your video wall screens
3. Connect any input to their corresponding signal source (Blu-Ray player, computer, etc)
4. Optionally connect the IR receiver to the IR input jack at the back of the EZWall-Pro.
5. Optionally connect an RS-232 cable from a PC to the RS-232 port of the unit for additional control.
6. Optionally connect an Ethernet cable to the EZWall-Pro for additional control over the internet (TCP/IP)
7. Turn on the EZWall-Pro.
8. Wait for a few seconds for the unit to initialize.

## INSTALLATION DIAGRAM

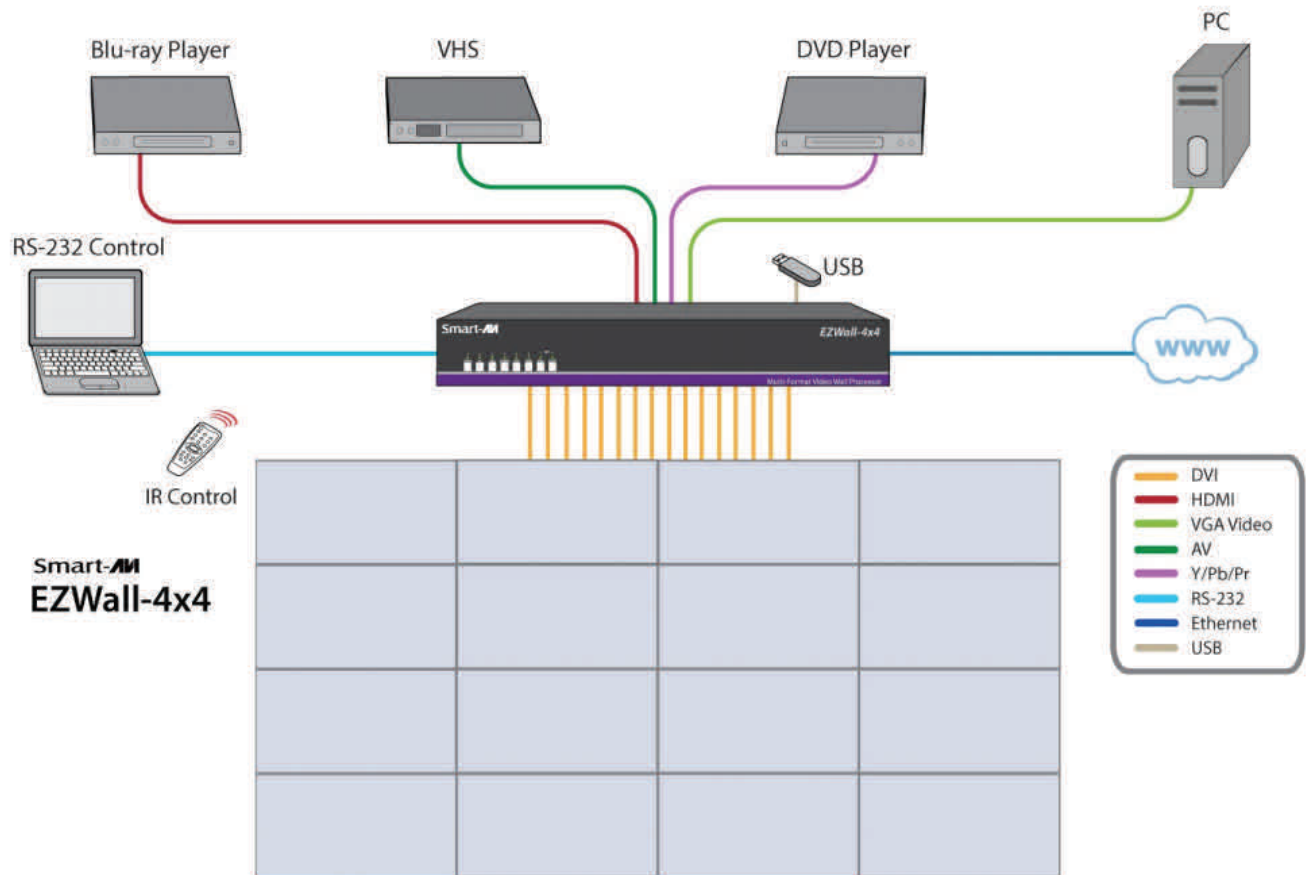

Figure 5-1

## FRONT PANEL CONTROL

To switch to Video Wall mode, press the WALL button.

To switch to Clone mode, press the CLONE button.

To switch between listed sources, press:

1. AV 1
2. AV 2
3. VGA
4. Y/PB/PR
5. USB \*
6. HDMI (Press once for HDMI 1 and twice for HDMI 2)



Figure 6-1

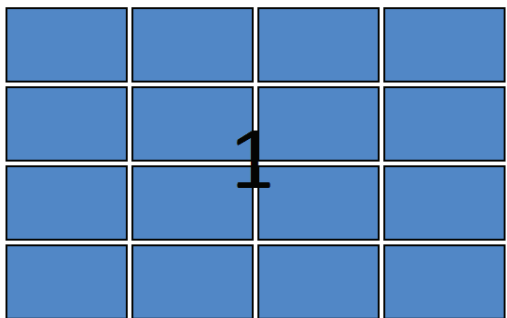

**WALL MODE:** Users can project the input image across sixteen HD screens (4x4 configuration).

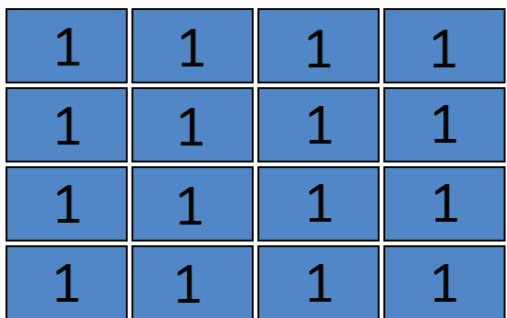

**CLONE MODE:** Users can route the input image to each display individually.

Figure 6-2

\* USB player requires the IR Remote Control for navigation and media selection.

## RS-232 COMMANDS

The EZWall-Pro may also be controlled via RS-232 commands. This feature requires that an RS-232 card is installed in your computer or a USB to RS-232 adapter. Check the RS-232 connections on your computer and the EZWall-Pro to determine if you need a male to male, female to female or male to female cable.

### Establish a connection to EZWall-Pro:

1. Connect a straight-through RS-232 cable to the RS-232 connector on the PC.
2. Connect the other end of the cable to the RS-232 port of the EZWall-Pro.
3. Power on the device.

If you are using a USB to COM port adapter and need to identify the COM port used do the following:

1. Click on the start button.
2. Click on Control Panel.
3. Click on Device Manager.
4. Click on the arrow next to Ports (COM & LPT).

You should see the name of your adapter and the COM port number in use.

### Setting up the Terminal Application:

Run the terminal client of your choice such as HyperTerminal or PuTTY.

Select the correct COM port on the PC.

Use the following connection settings: **9600, N, 8, 1, no flow control.**

Once the connection is established type //? And hit enter. The EZWall-Pro should respond with a firmware version number and a list of available commands.

COMMAND	DESCRIPTION
//?	Help (List of Commands)
//B	Boot EZWall-Pro
//C	Clone display mode
//I#	Select input (# = 1=HDMI1, 2=HDMI2, 3=VGA, 4=AV1, 5=AV2, 6=YPBPR, 7=USB*)
//QA	Query IP Address
//QC	Query available video Configurations
//QM	Query current Mode
//QF	Query Firmware version
//QS	Query current Status
//V	default Video Configuration (2X2)
//W	Wall
//Z	Sleep





Figure 7-1

\* USB player requires the IR Remote Control for navigation and media selection.

## IR REMOTE CONTROL

BUTTON	DESCRIPTION
WALL	Video Wall Mode (Figure 6-1)
CLONE	Clone Mode (Figure 6-2)
SOURCE	Pressing SOURCE followed by pressing a number will select the source port number. (Table 7-1)
F1	1X2 Mode * (Page 8, Figure 8-1)
F2	2X1 Mode * (Page 8, Figure 8-2)

## USB PLAYER REMOTE CONTROL \*\*

BUTTON	DESCRIPTION
<b>While Navigating ON Screen Menus</b>	
USB	Pressing USB followed by pressing number 1 or 2 will select the USB port.
[OK] Center Button	Enter or Select
CH+	Navigate UP
CH-	Navigate DOWN
 -	Navigate LEFT
 +	Navigate RIGHT
<b>While Videos or Pictures are displayed</b>	
[OK] Center Button	DISPLAY MENU
CH-	TURN OFF MENU
 +	VOLUME UP
 -	VOLUME DOWN

\* Note that when not using all four displays the unused displays will be a clone of output #1

\*\* The USB player requires the IR Remote Control for navigation and media selection.

## STAND BY



Source Port Numbers:

1. VGA
2. HDMI 1
3. HDMI 2
4. Y/PB/PR
5. AV 1

Table 8-1



## CONTROL VIA ETHERNET

EZWall-Pro TCP/IP control is a feature that allows mode switching and other configurations to be controlled remotely via HTTP. Manage your EZWall-Pro with ease from anywhere in the world.

First you must find the IP address for the EZWall-Pro. Finder.exe (Smart IP-Finder) is conveniently available on our website; please visit [www.smartavi.com/helpful-links.html](http://www.smartavi.com/helpful-links.html) for this and our full list of compatible third-party software. Download and execute the IP address Finder software for your product. The EZWall-Pro and its IP address should appear in the display as shown in Figure 9-1.

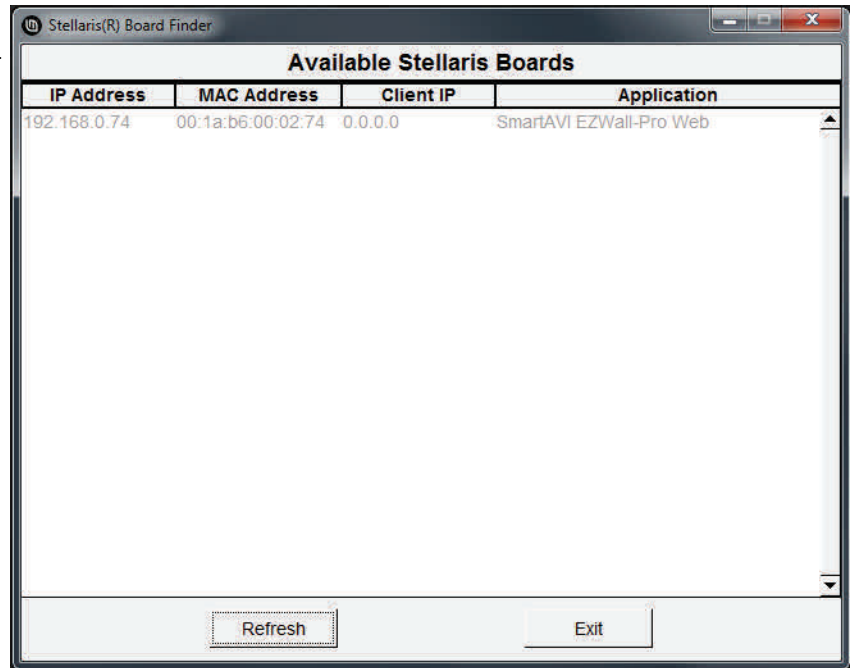

Figure 9-1

## CONTROL VIA ETHERNET (Continued)

Enter the IP address into a web browser of your choice.  
You should see the EZWall-Pro Home/Welcome page.

Click on the LOG IN tab in the top tool bar.  
Enter the User ID and Password in the Login page.  
The User ID and Password are case sensitive.  
User ID = admin, Password = 1234

You can change the User ID and password by clicking the ADMINISTRATION button. See Figure 10-1

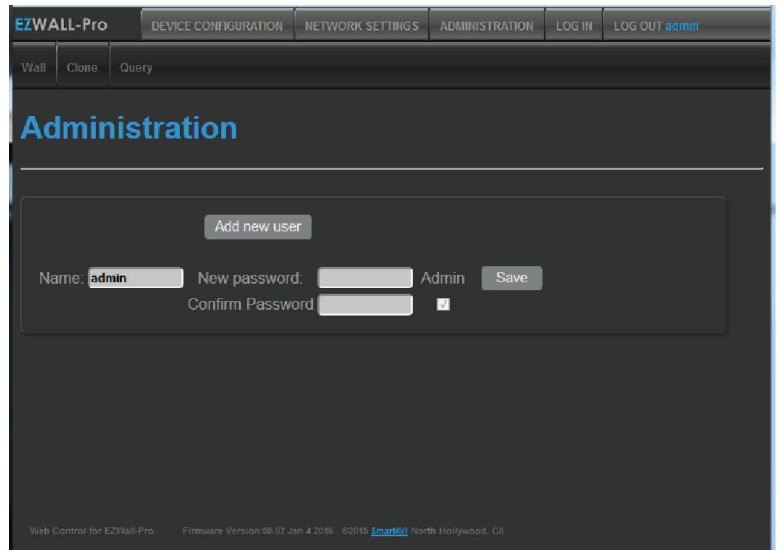

Figure 10-1

Click the Network Settings tab in the top toolbar to configure your network settings.  
See Figure 10-2.

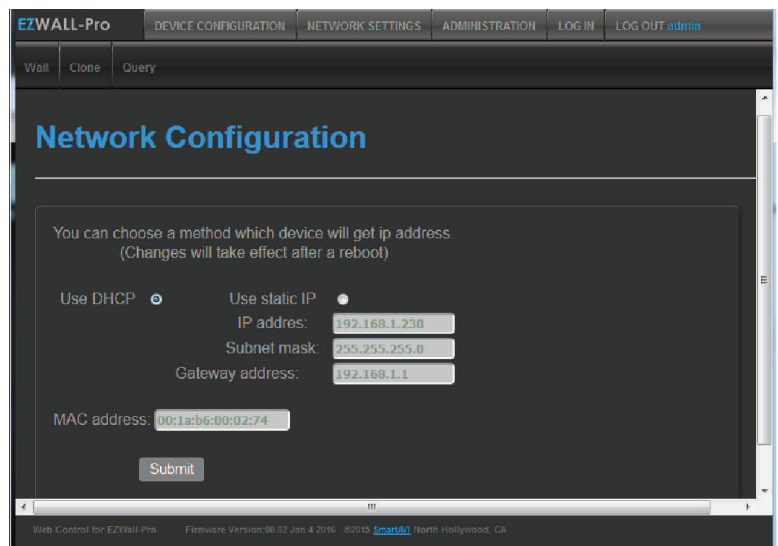

Figure 10-2

## CONTROL VIA ETHERNET (Continued)

You can use the internal web page to set the EZWall-Pro to Wall Mode or Clone Mode and set the desired source\*. See Figure 11-1.

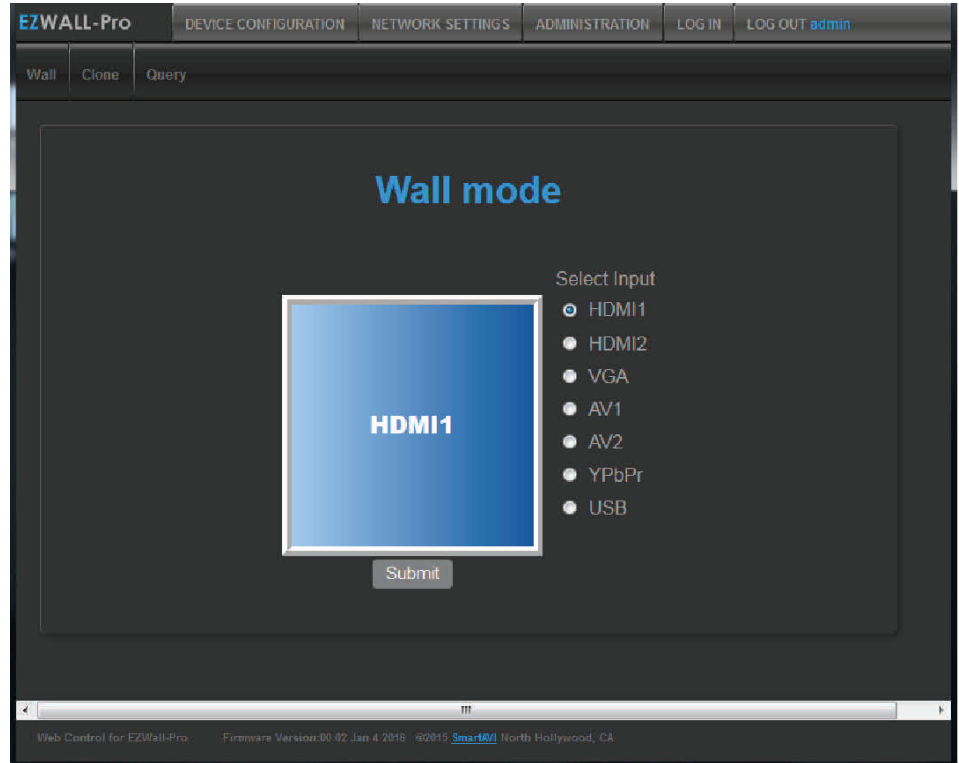

Figure 11-1

\* USB player requires the IR Remote Control for navigation and media selection.

# FIRMWARE UPDATE

## Identify the COM port on your PC.

1. Click the Start button in the lower left corner of your Windows PC.
2. Click on Control Panel.
3. Click on Device Manager.
4. Click on the arrow next to "Ports (COM & LPT)".
5. You should see the COM port number.

## Download and install the chip45boot2 GUI software in your PC.

Copy the website location below into your browser and download the chip45boot2 firmware installer software.

[http://download.chip45.com/chip45boot2\\_GUI\\_V1.13.zip](http://download.chip45.com/chip45boot2_GUI_V1.13.zip)

Contact Smart-AVI support for the current firmware.

1. Power OFF the EZWall-Pro.
2. Connect the RS-232 cable from the computer to the RS-232 port of the EZWall-Pro.
3. Open the chip45boot2 GUI.
4. Connect to your active COM port using: 9600 Baud, No parity, 8 data bits, 1 stop bit, No flow control.
5. Initially the Status light in the lower right side of the chip45boot2 window will be dark. Status will appear next to it. The boot loader in the EZWall-Pro is only accessible for a few seconds after you power up the EZWall-Pro. Immediately after turning on the power switch on the EZWall-Pro you must click the "Connect to Boot loader" button in the chip45boot2 window. You only have a second to connect. If you connect successfully to the boot loader the Status light will turn green and connected will appear next to it. If it doesn't connect the Status light will turn red and Failed will appear next to it. If you fail to connect, power off the EZWall-Pro and try again. See Figure 12-1.

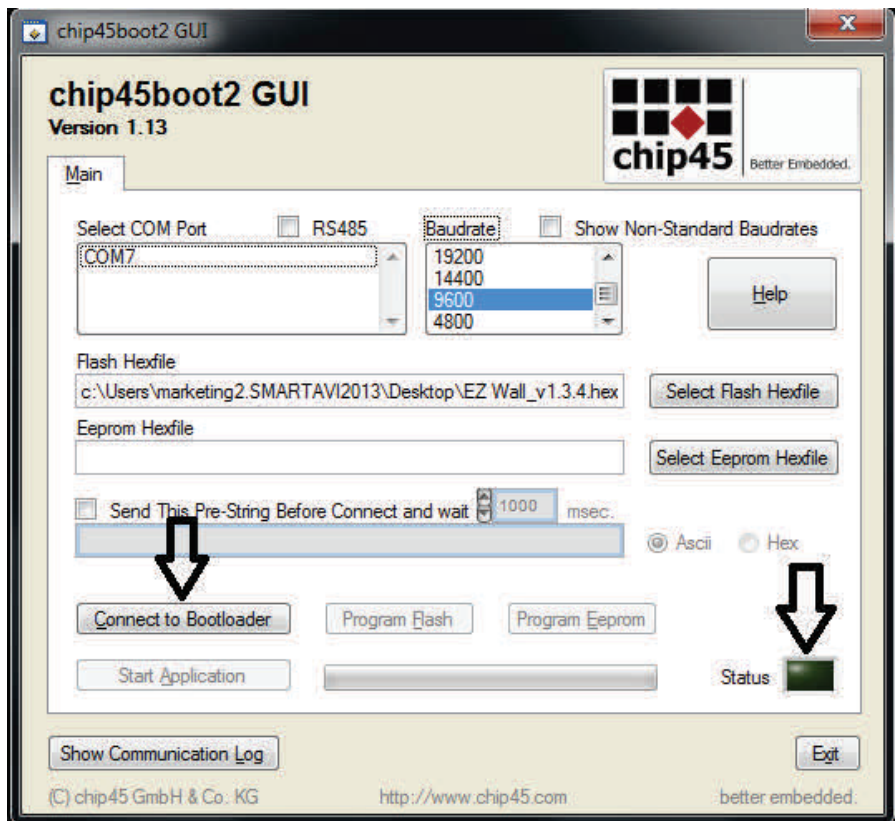

Figure 12-1

## FIRMWARE UPDATE (Continued)

Click on the "Select Flash Hexfile" button. Navigate to and select the .hex firmware file.

Click the "Program Flash" button. A green progress bar will display under the "Program Flash" button. The Status light will turn yellow and display "Uploading". See Figure 13-1.

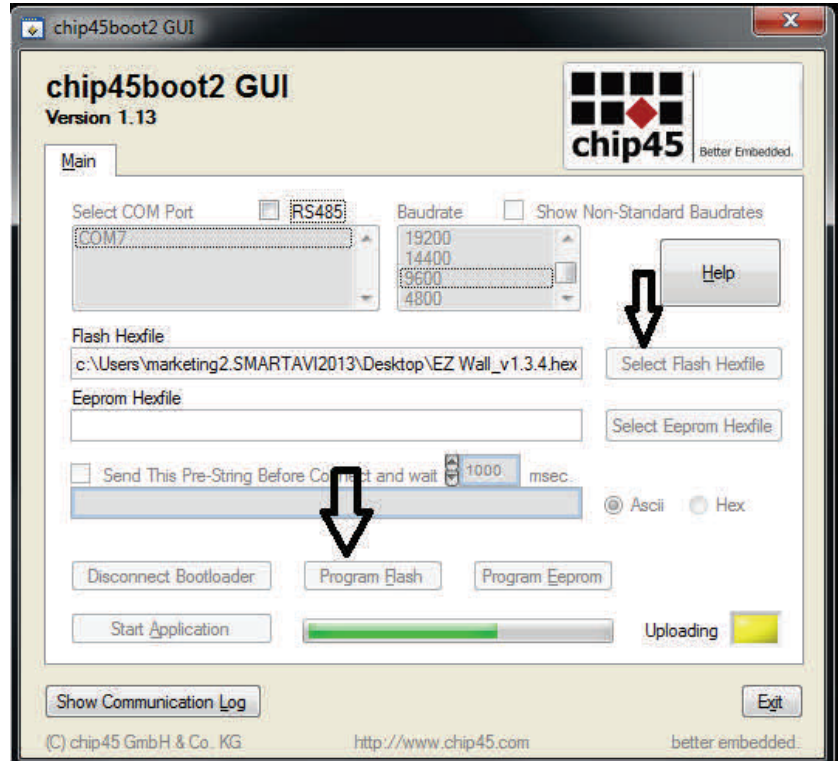

Figure 13-1

Upon successful completion the Status light will turn green and display Done! See Figure 13-2.

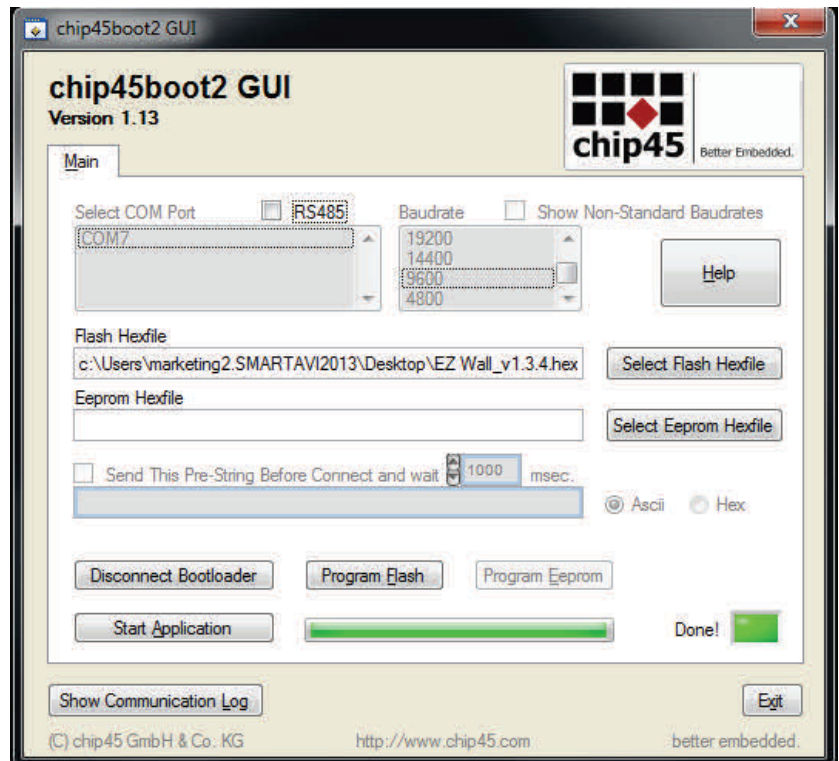

Figure 13-2

## LIMITED WARRANTY STATEMENT

### A. Extent of limited warranty

Smart-AVI Technologies, Inc. warrants to the end-user customers that the Smart-AVI product specified above will be free from defects in materials and workmanship for the duration of 1 year, which duration begins on the date of purchase by the customer. Customer is responsible for maintaining proof of date of purchase.

Smart-AVI limited warranty covers only those defects which arise as a result of normal use of the product, and do not apply to any:

- a. Improper or inadequate maintenance or modifications
- b. Operations outside product specifications
- c. Mechanical abuse and exposure to severe conditions

If Smart-AVI receives, during applicable warranty period, a notice of defect, Smart-AVI will at its discretion replace or repair defective product. If Smart-AVI is unable to replace or repair defective product covered by the Smart-AVI warranty within reasonable period of time, Smart-AVI shall refund the cost of the product.

Smart-AVI shall have no obligation to repair, replace or refund unit until customer returns defective product to Smart-AVI.

Any replacement product could be new or like new, provided that it has functionality at least equal to that of the product being replaced.

Smart-AVI limited warranty is valid in any country where the covered product is distributed by Smart-AVI.

### B. Limitations of warranty

To the extent allowed by local law, neither Smart-AVI nor its third party suppliers make any other warranty or condition of any kind whether expressed or implied with respect to the Smart-AVI product, and specifically disclaim implied warranties or conditions of merchantability, satisfactory quality, and fitness for a particular purpose.

### C. Limitations of liability

To the extent allowed by local law the remedies provided in this warranty statement are the customers sole and exclusive remedies.

To the extent allowed by local law, except for the obligations specifically set forth in this warranty statement, in no event will Smart-AVI or its third party suppliers be liable for direct, indirect, special, incidental, or consequential damages whether based on contract, tort or any other legal theory and whether advised of the possibility of such damages.

### D. Local law

To the extent that this warranty statement is inconsistent with local law, this warranty statement shall be considered modified to be consistent with such law.

# Smart-AVI

SMART AUDIO VIDEO INNOVATION

## NOTICE

The information contained in this document is subject to change without notice. SmartAVI makes no warranty of any kind with regard to this material, including but not limited to, implied warranties of merchantability and fitness for particular purpose. SmartAVI will not be liable for errors contained herein or for incidental or consequential damages in connection with the furnishing, performance or use of this material. No part of this document may be photocopied, reproduced, or translated into another language without prior written consent from SmartAVI Technologies, Inc.

20160613



**Designed and Manufactured in the USA**

**800.AVI.2131**

**Tel: (818) 503-6200 Fax: (818) 503-6208**

**11651 Vanowen St. North Hollywood, CA 91605**

**SmartAVI.com**