

SM-DVN-4S

FORMERLY DVN-4P-DL

4-PORT DVI-I DUAL LINK KVM SWITCH WITH USB 2.0 SHARING



**ACCESS AND CONTROL UP TO 4 DVI, VGA OR HDMI COMPUTERS
FROM A SINGLE USB KEYBOARD/MOUSE AND MONITOR**

FEATURES

- DVI-I Dual Link Video Connectors; can mix DVI Dual-Link, DVI Single-Link and VGA Computers
- HDMI and VGA support using inexpensive passive adapters or cables
- Supports all major Operating Systems like Windows, Mac, Linux, Sun, Unix, DOS, etc.
- Supports resolutions up to 2560 x 1600 @ 60Hz
- Zero pixel loss with TMDS signal correction
- Supports USB keyboard and mouse
- Supports additional USB 2.0 devices like printers, scanners, web cameras and more
- Flash upgradeable firmware
- Stereo Audio support
- Front panel keys for manual port selection
- Hot-key commands for quick port selection
- RS-232 for remote control
- Independent (asynchronous) switching of KVM and peripheral USB/audio ports. Users can listen to audio from one computer while working on a different computer, or scan a document and save it on another computer
- Complete keyboard emulation for error free booting

APPLICATIONS

- Server Collocation
- Digital Signage
- Education
- Airports
- Dealer Rooms
- Control Rooms
- Audio/Visual Presentations
- Shopping Centers
- Hotels/Resorts



Designed and Manufactured in the USA

OVERVIEW

The SM-DVN-4S (formerly DVN-4P-DL) is a dedicated multi-platform KVM Switch capable of managing up to 4 different computers through a single monitor, USB keyboard & mouse, a set of speakers and USB devices like printers, memory devices, scanners, etc. The video connectors on the unit are DVI-I, which allows support for HDMI and VGA using inexpensive passive adapters or cables. When using a DVI or an HDMI monitor, computers can be a mix of either DVI or HDMI. When utilizing a VGA monitor, all computers must have a VGA/ Analog video connection.

The SM-DVN-4S supports resolutions of up to 2560x1600 @60Hz with zero pixel loss from TMDS signal correction.

APPLICATION DIAGRAM

The main function of this KVM Switch is to centralize the access of several computer into a single, comprehensive KVM Station. Its USB 2.0 functionality support allows users at the console to access USB devices that would otherwise be unavailable on conventional KVM Switches. For example, it allows the use of a flash memory drive or camera without having to plug it directly into the remote computer. The SM-DVN-4S is a perfect solution for the medical or industrial field where it may not be practical or safe to have on or more CPUs in the general vicinity.

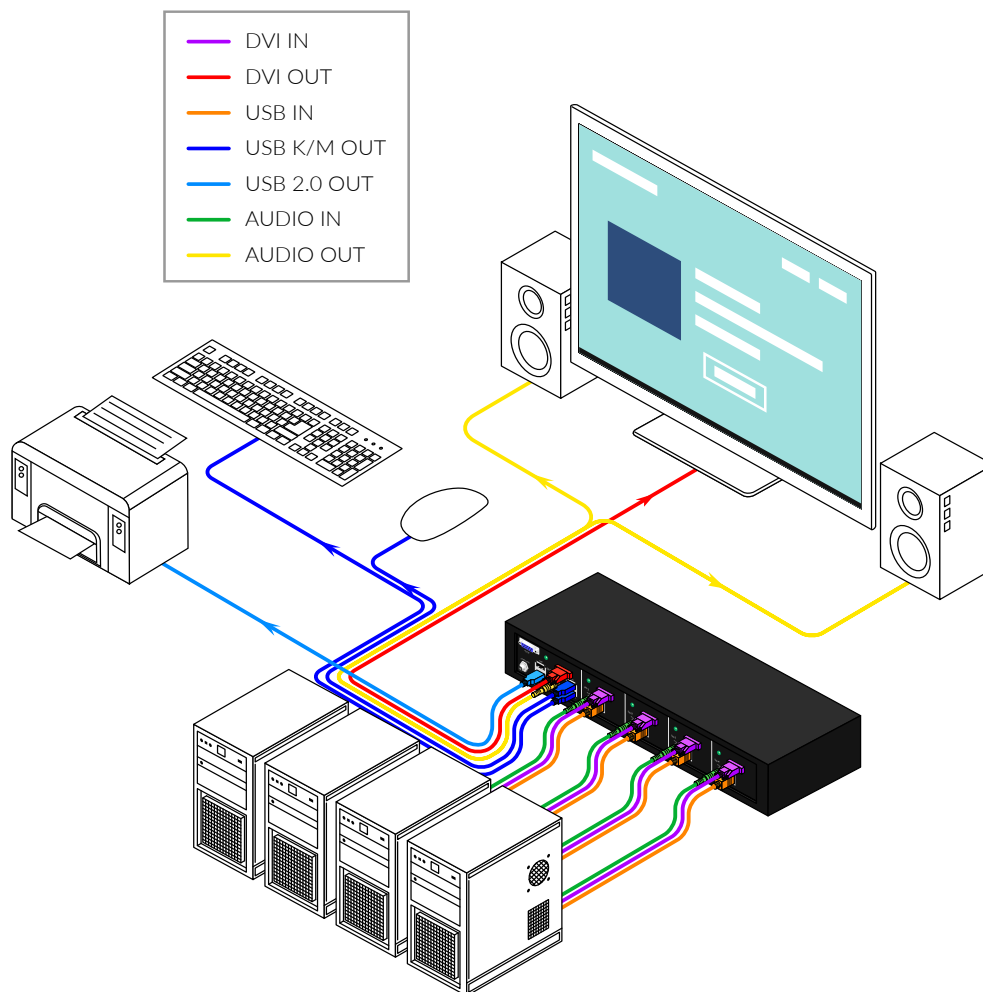

FLEXIBLE CONTROL

RS-232

Any external device or program supporting RS-232 can control the SM-DVN-4S. The SM-DVN-4S uses a very simple protocol, enabling easy integration with the RS-232 control devices.

USB/KEYBOARD

Hot keys enable the user to switch and control all the different functions of the KVM Switch

FLEXIBLE SHARING

INDEPENDENT SIMULTANEOUS DEVICE SELECTION

Flexibility is key with the SM-DVN-4S. It enables the use of a USB keyboard and mouse on one computer while other USB peripherals such as speakers, scanners and printers are connected to other computer sources. The SM-DVN-4S maintains the ability to switch all connected devices to any one of the computer sources as with any other KVM Switch in the market.



SM-DVN-4S Back



SM-DVN-4S Front

TECHNICAL SPECIFICATIONS

VIDEO	
Format	DVI Dual Link; DVI Single-Link; VGA
Maximum Pixel Clock	165 MHz
Input Interface	(4) DVI-I 29-pin
Output Interface	(1) DVI-I 29-pin
Resolution	DVI Dual-Link: 2560 x 1600; DVI Single-Link: 1920 x 1200; VGA: 1920 x 1080
Color Mode	24-bit
DDC	5 volts p-p (TTL)
Input Equalization	Automatic
Input Cable Length	Up to 20 ft.
Output Cable Length	Up to 20 ft.
Data Rate	1.65 Gbps per color
Console Monitors	Supports both digital and analog monitors

AUDIO	
Input Interface	(4) 3.5 mm Stereo Audio
Output Interface	(1) 3.5 mm Stereo Audio
Impedance	600 Ohm
Frequency Response	20 Hz to 20 kHz
Nominal Level	0-1.0 V
Common Mode	Rejection at 60 dB

PART NO.	DESCRIPTION
SM-DVN-4S-S (formerly DVN-4P-DL)	4-Port DVI-I Dual Link KVM Switch with Audio and USB 2.0 Support. Includes: [SM-DVN-4S, and PS12VD2A]

SOFTWARE COMPATIBILITY	
Operating Systems	Operates with virtually any OS including Windows, DOS, Linux, Unix, Sun, Mac, etc.

USB	
Signal Type	USB 2.0, 1.1, and 1.0 w/ internal hub
Input Interface	(4) USB Type B
Output Interface	(2) USB 1.1 Type A for KVM Devices; (2) USB 2.0 Type A Transparent

CONTROL	
Front Panel	Push Buttons with LED Indicators
RS-232	Via Control @ 115200 bps
Hot Keys	Via Keyboard

OTHER	
Power	External 100-240 VAC/12VDC2A @ 24W
Dimensions	12.57" W x 1.76" H x 6.69" D
Weight	4.2 lbs
Approvals	UL, CE, ROHS Compliant
Operating Temperature	+32 to +104°F (0 to +40°C)
Storage Temperature	-4 to 140°F (-20 to +60°C)
Humidity	Up to 80% (No Condensation)
Emulation	Keyboard and Mouse